

Lighting Control With Bluetooth® Wireless Technology

HYTRONIK®

HC438V/BT HCD038/BT
Built-in Detached Version



Applications

The freedom of wireless mesh networks configured by smartphone APP's considerably changes the approach to connected lighting controls. Hytronik has designed such lighting controls using Bluetooth® 4 wireless mesh technology to support the functional demands of most commercial and industrial applications:

- Office / Commercial Lighting
- Classrooms
- Car Parks
- Stairwells / Corridors
- High-bay / Low-bay warehouse



HC438V/BT 1-10V Control Base with Bluetooth Transceiver

A Bluetooth transceiver node with 1-10V dimming output, the linear shape control base HC438V/BT can be built behind the PCB board. It is also perfect for applications where space is restricted for cables and externally mounted lighting controls. Features manual switch input and port for a range of miniature antennas.















HCD038/BT DALI Control Base with Bluetooth Transceiver

This device contains the same features of the HC038V/BT above. Instead of 1-10V dimming output, the HCD038/BT features DALI control with a 30mA power supply for up to 15 LED driver connections.

Bluetooth® 4 wireless mesh lighting control with DALI or 1-10V output

Both HC438V/BT and HCD038/BT works with a range of different sensor heads to meet the requirements of various applications.

Features

-  30mA Broadcast DALI output for up to 15 LED drivers per node
-  1-10V output control option
-  Photocell Advance™ built-in daylight control.
-  Daylight harvest function to regulate light output for maintaining required lux level
-  Tri-level dimming control based upon occupancy (also known as corridor function)
-  Free smartphone (iOS and Android) App for set-up and commissioning:
 -  Scene control
 -  Scheduling
 -  Push switch configuration: recall scene
 -  Astro timer
-   Switch-Dim with Synchronization for simple manual over-ride
-  Permanent Settings Memory, Protected against Loss of Power
-  5 Year, 50,000hr Warranty

Free smartphone App for set-up and commissioning



iOS

Compatible with iOS 9.0 or later



ANDROID

Compatible with Android 5.0 or later

Note:

This datasheet is intended for information related to the hardware only.

For detailed set-up of features available in the App, please refer to the App user guide available from our website.

Technical Data For Control Base (HC438V/BT HCD038/BT)

Input Characteristics	
Mains voltage	120~277VAC 50/60Hz (HC438V/BT) 220~240VAC 50/60Hz (HCD038/BT)
Stand-by power	<1W
Load ratings:	
HC438V/BT	Capacitive: 120V/1.7A/200VA; 277V/1.5A/400VA Resistive: 120V/4.2A/500W; 277V/4.2A/1200W
HCD038/BT	30mA (max. 15 devices)
Warming-up	20s

Bluetooth Transceiver	
Operation frequency	2.4 GHz - 2.483 GHz
Transmission power	7dBm
Range (Typical) *	15~30m

* Please refer to placement guidance provided later in this document .

Environment	
Operation temperature	Ta: -20°C ~ +55°C
Case temperature (Max.)	Tc: +80°C
IP rating	IP20



Safety and EMC (Common Data)	
EMC standard (EMC)	FCC part 15
Safety standard (LVD)	UL773A
Certification	FCC, cULus (coming soon)

HC438V/BT (1-10V output)

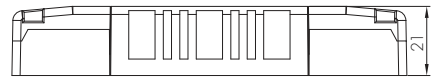
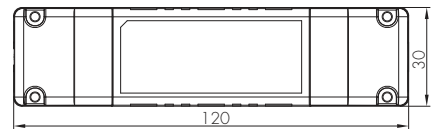
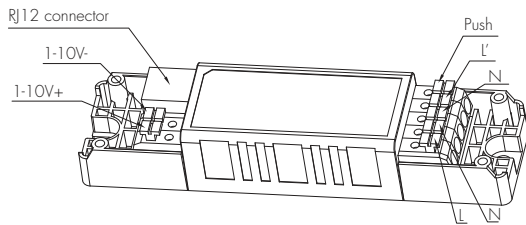

HCD038/BT (DALI output)

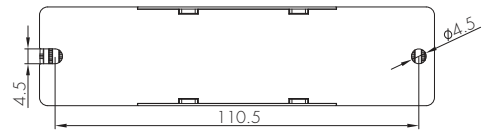
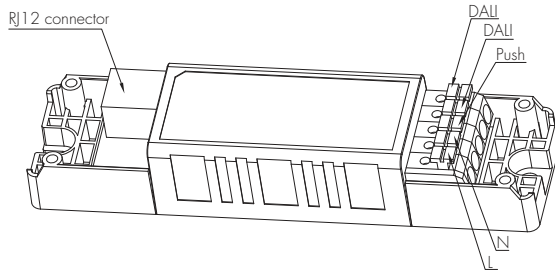

Wire Preparation

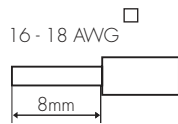

To make or release the wire from the terminal, use a screwdriver to push down the button.

To maximise the bluetooth transmission range in every direction, the following considerations should be taken into account when situating the control base in the luminaire:

HC438V/BT HCD038/BT

The control base contains the **Bluetooth**® transceiver module and is located within the device as per fig. 1.

fig. 1.

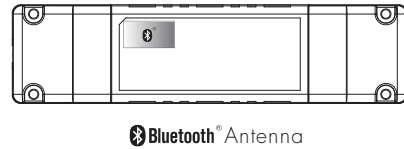

When the antenna is mounted to a metallic backplane, such as a gear tray, a cut-out opening should be made as large as possible as shown in fig.2.

fig.2.

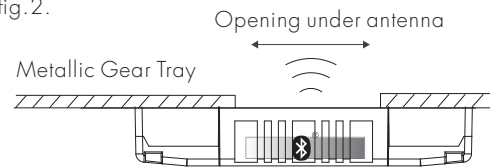

If possible, try to position the sensor as far away as possible from the LED Driver or other strong sources of HF interference.

Device to Device Placement

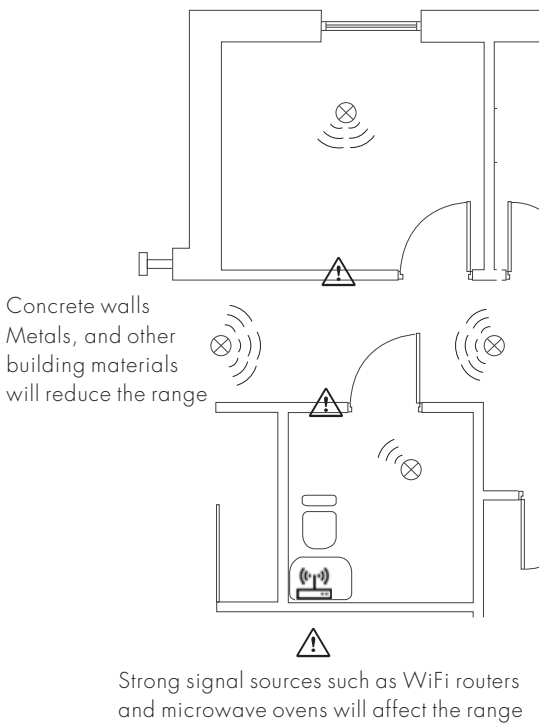

Device placement may offer up to 30m communication distance. However, we recommend for indoor applications that device placements should be no further apart than 1.5m.

Smart Phone to Device Range

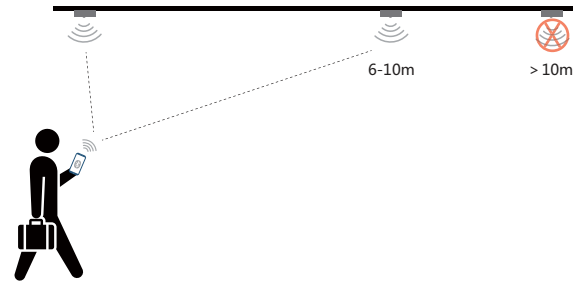

Notes:

The range for which a smart phone can communicate with the lighting points will vary from model to model and is dependant on its **Bluetooth**® capability.

Placement of the antenna within the luminaire will also effect the smart phone communication range and may appear different for each luminaire variant.

Finally, other environmental factors (as per opposite) will influence the ultimate achievable range of communication between smart phone and luminaire device.

1-10V version

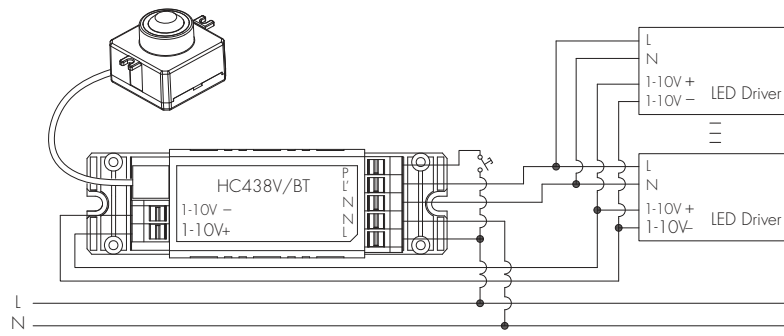

DAII version

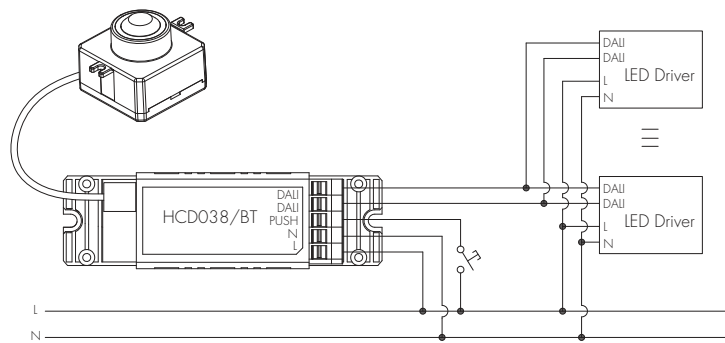

Hytronik offers multiple occupancy sensor heads to work with the HC438V/BT and HCD038/BT:

A. HIR05

PIR sensor head
Daylight harvest
The cable length is around 65cm.

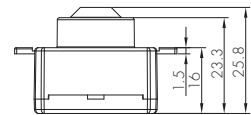
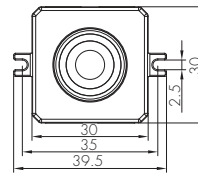
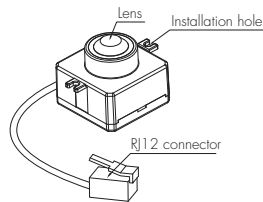

B. HIR07

PIR sensor head
Photocell Advance™
Daylight harvest
The cable length is around 30cm.

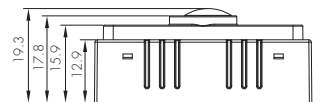
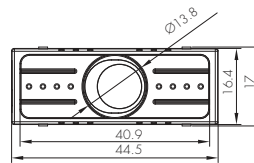
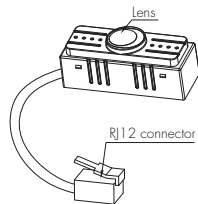

C. HIR11/S

PIR sensor head
Surface mounting
Daylight harvest
For highbay application
IP64
The cable length is around 65cm.

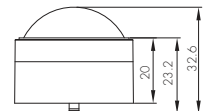
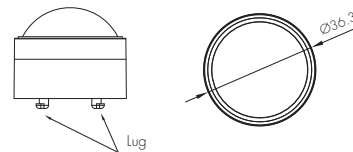
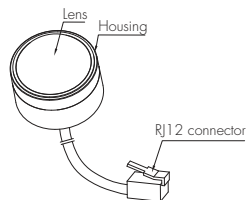

D. HIR11/F

PIR sensor head
Flush mounting
Daylight harvest
For highbay application
IP64
The cable length is around 65cm.

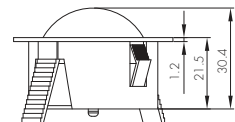
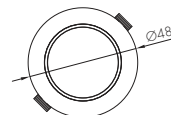
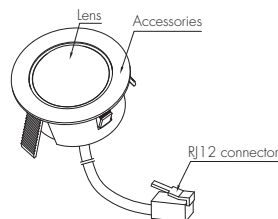

E. HIR11/C

PIR sensor head
Screw to the luminaire by conduit
Daylight harvest
For highbay application
IP64
The cable length is around 65cm.

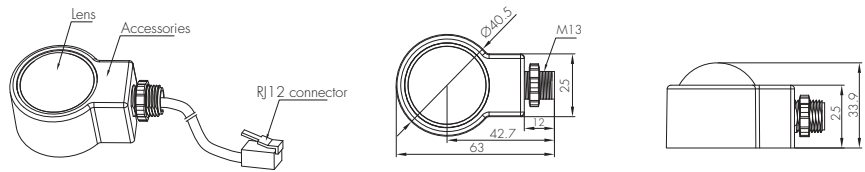

F. HIR12

PIR sensor head
Daylight harvest
For highbay application
IP65
The cable length is around 65cm.

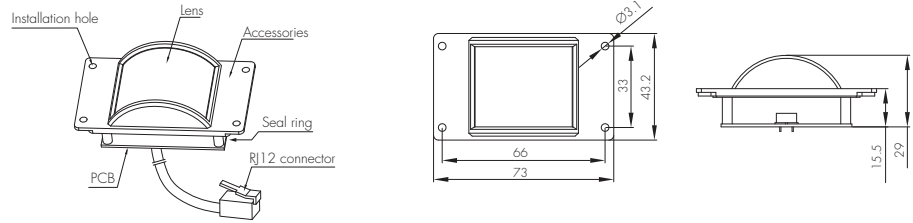

G. HIR12/L

PIR sensor head
Daylight harvest
For lowbay application
IP65
The cable length is around 65cm.

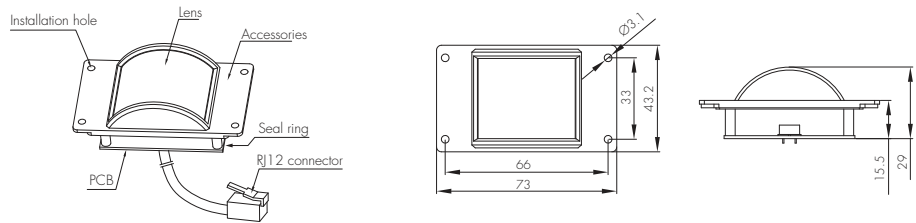

H. SAM20

HF sensor head
Photocell Advance™
Daylight harvest
The cable length is around 30cm.

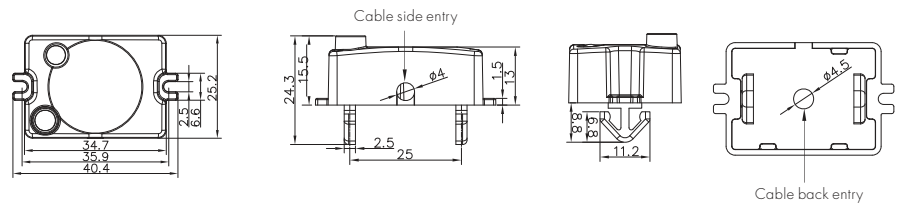

I. SAM21

HF sensor head
Daylight harvest
IP65
The cable length is around 65cm.

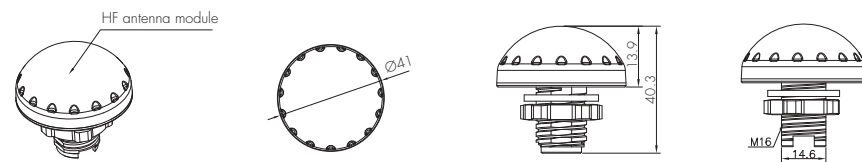

J. SAM22

HF sensor head
Daylight harvest
Flush mount
The cable length is around 65cm.

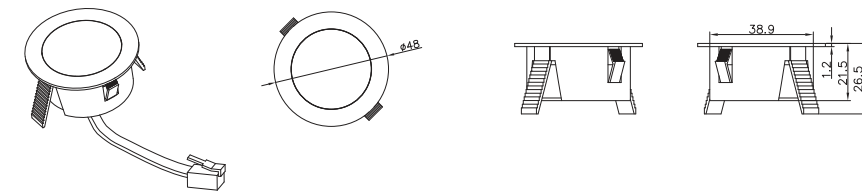

K. SAM23

HF sensor head
Photocell advance™
Daylight harvest
For highbay application
The cable length is around 30cm.

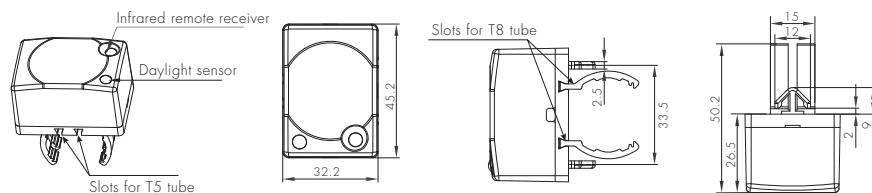

Note:
HA01 can also function as Bluetooth range extender to boost the signal of your smart device when using with SAM23, HIR11, HIR12.



Technical Data For Sensor Heads

PIR Sensor Properties	
Sensor principle	PIR detection
Operation voltage	5VDC
Detection range *	HIR05 / HIR07 (∅ x H) 6m x 3m HIR11 (∅ x H) 16m x 12m HIR12 (L x W x H) 16m x 5m x 12m HIR12/L (L x W x H) 8m x 5m x 3m
Detection angle	360°

HF Sensor Properties	
Sensor principle	High Frequency (microwave)
Operation frequency	5.8GHz +/- 75MHz
Transmission power	<0.2mW
Detection range *	SAM20 / SAM21 / SAM22 (∅ x H) 12m x 3m SAM23 (∅ x H) 16m x 12m
Detection angle	30° ~ 150°

* The detection range is heavily influenced by antenna placement (angle of approach) and different walking paces. It may be reduced under certain conditions.

Detection Pattern

SAM23

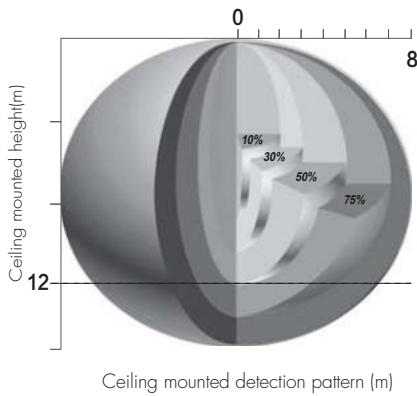

SAM20 / SAM21 / SAM22

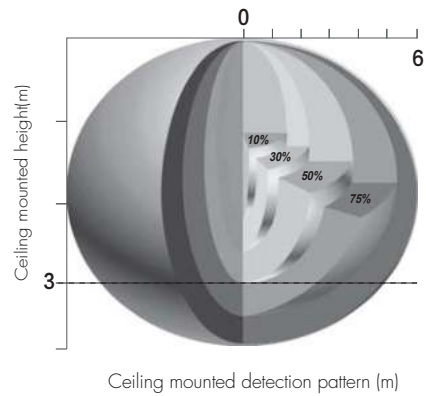

HIR05 / HIR07

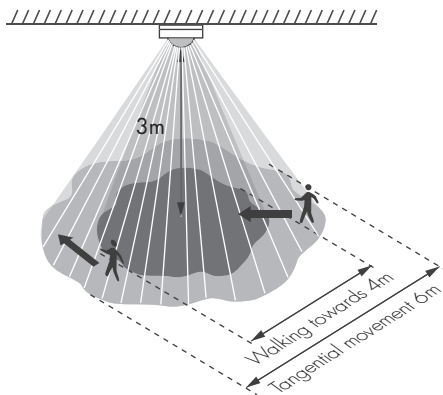

HIR11

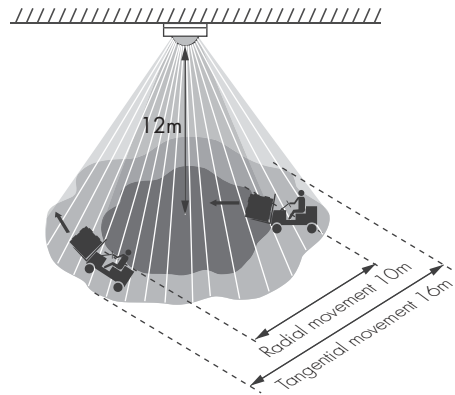

HIR12

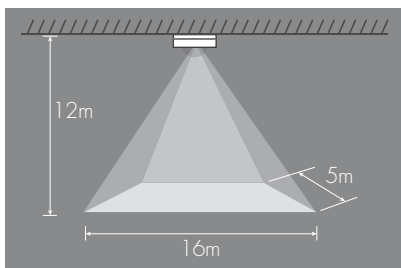

HIR12L

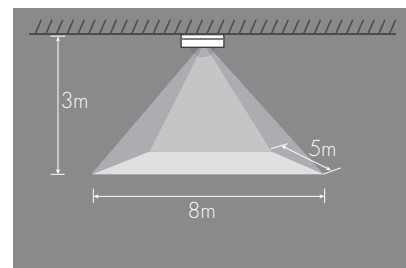

1 Bluetooth Transceiver Node

The HC438V/BT and HCD038/BT can either be linked to the occupancy sensor head for automated control, or take commands from elsewhere via bluetooth transmission. There are many ways to control the sensor:

- a. Use the APP for sensor parameters set-up and other advanced functions such as scheduling, holiday mode, etc
- b. Other Hytronik Bluetooth occupancy sensors such as HBT01, HBIR29, etc for automated control by presence/absence.
- c. Hytronik Bluetooth wall panels for on/off and dimming control, scene selection
- d. Push switch on the bluetooth products, such as dimmer HBTD8200T, for on/off and dimming control

2 Photocell Advance™ Technology (HIR07, SAM20, SAM23)

It is well known that LED lights have a totally different spectrum to natural light. Hytronik uses this principle with a custom-designed photocell and sophisticated software algorithm to measure and differentiate natural light from LED light, so that this photocell can ignore the LED light and only respond to the natural light.

3 Zero-cross Relay Operation (HC438V/BT)

Designed into the software, the relay switches the load right at the zero-crossing point, to ensure that the in-rush current is minimised thus enabling the maximum lifetime of the relay.

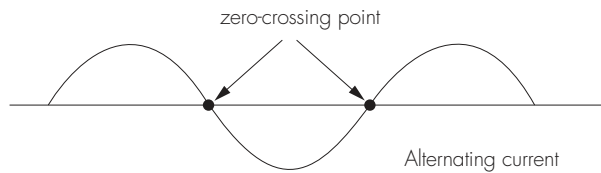

4 Daylight Harvest Function

With built-in daylight sensor, the sensor can achieve daylight harvest function for energy saving purpose. Simply activate the daylight harvest function in the App, and it will automatically adjust the light output according to the change of natural light.

Daytime

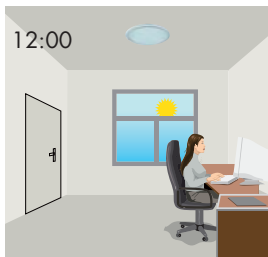

Light will not switch on when natural light is sufficient.

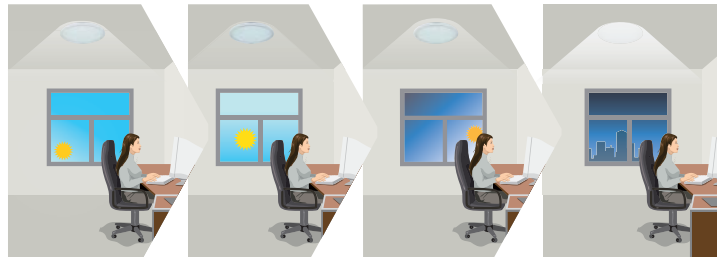

The light turns on at full or dims to maintain the lux level. The light output regulates according to the level of natural light available.

At night

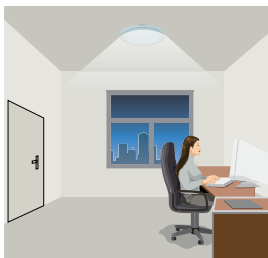

The light automatically switches on when natural light is insufficient.

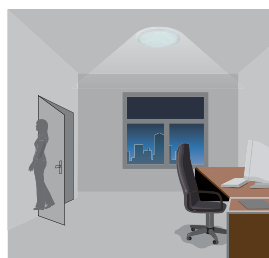

The light goes to stand-by time after hold-time and stays on dimming level preset.



The light is automatically switched off after stand-by time.

Note:

Tri-level control is also achievable. Simply choose this function on the APP, daylight harvest is then inactivated.

5 Manual Override ('Push' Terminal)

The 'push' terminal reserves the access of manual override function for the end-user to switch on/off, or adjust the light level by push-switch. Furthermore, by using the binding option in the App, entire groups of fixtures may be wirelessly controlled by a single switch. Please refer to the App user guide for further information.

- * Short Push (<1s): permanent on/off function; can also be configured to recall scene selection.
- * Long Push (>1s): Brightness level adjustment or color tuning (for DALI version only).

Notes:

- 1) Both the adjustment on App and push switch can overwrite each other, the last adjustment remains in memory.
- 2) The switch functions are configured in the App.
- 3) The push terminal may be left unconnected if no manual control is required.