

Detached PIR Sensor Daylight Harvest

Model: HIR01 + HC438V
HIR01 + HCD438

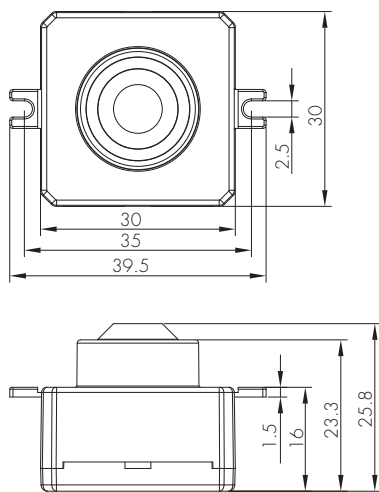

PIR Sensor Head

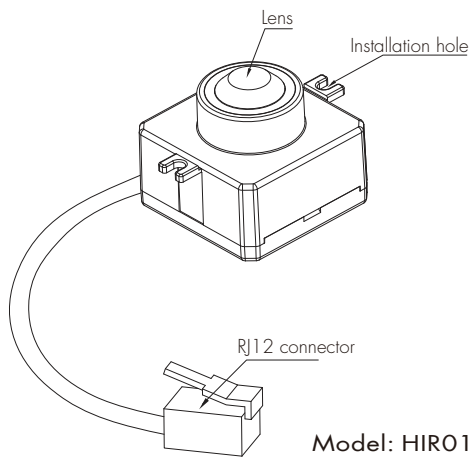

Mechanical structure (mm)

Main body

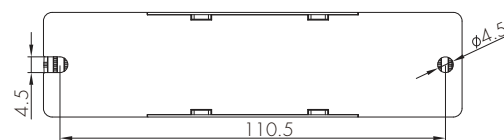
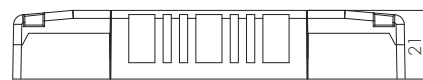
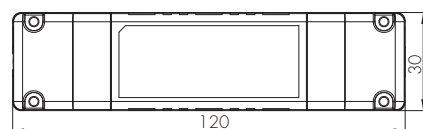
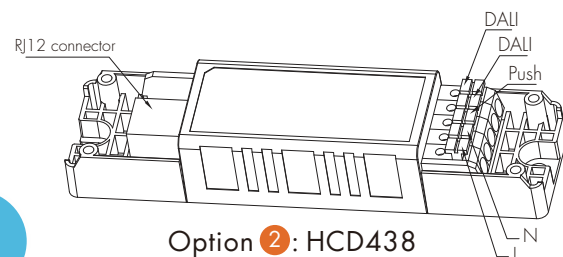
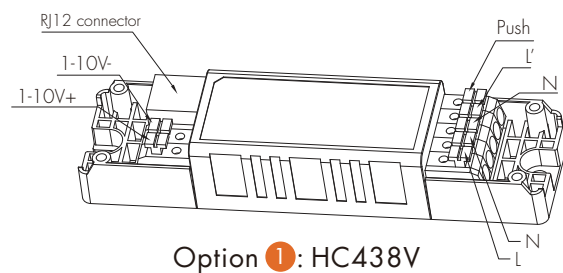

Mechanical structure (mm)

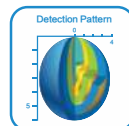
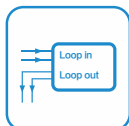
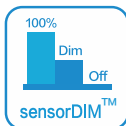

Product Functions and Features

1 Wall switch manual override (push function)

2 Wire loop-in and loop-out (HC438V)

3 Daylight harvest (daylight regulating)

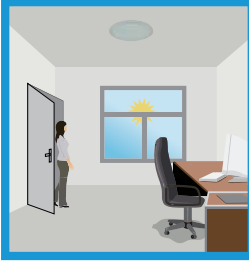

Light will not switch on when natural light is sufficient, even there is motion detected.

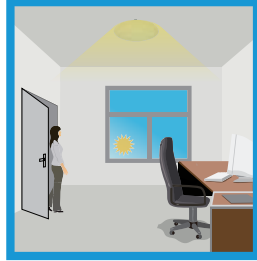

Light switches on automatically with presence and the natural light is insufficient.

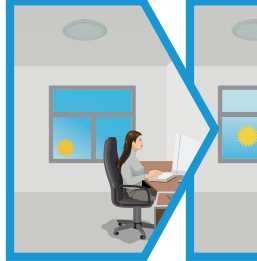

The lamp turns on at full or dims to maintain the lux level, light output regulates according to the level of natural light available.

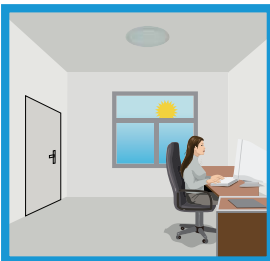

Light will be switched off when the ambient natural light is sufficient.

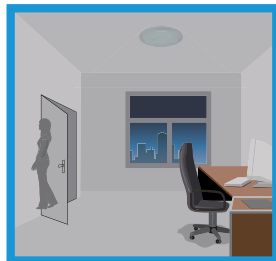

Light dims to stand-by brightness after hold-time. In stand-by period, the light stays on the selected minimum level.

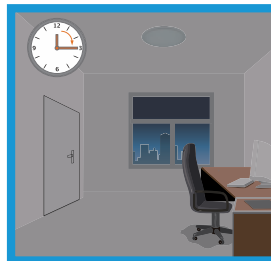

Light switches off automatically after the stand-by period.

Note:

Light will automatically dim down even turn off if surrounding natural light lux level is above the daylight threshold, even there is motion detected. However, if the stand-by period is preset at "+∞", light will never switch off but dim to minimum level, even when natural light is sufficient.

Wiring Diagram

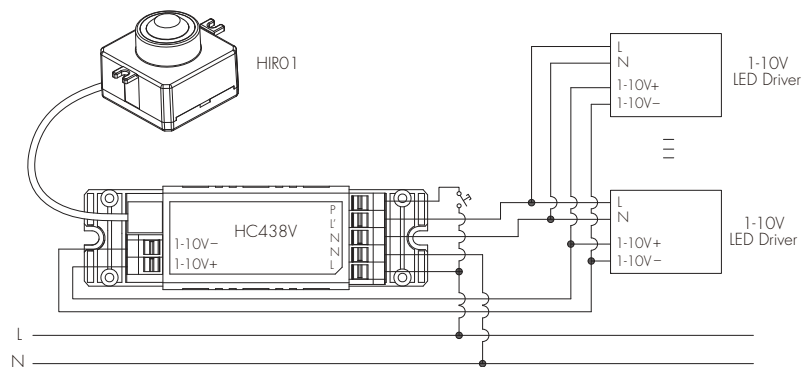

Wiring Diagram

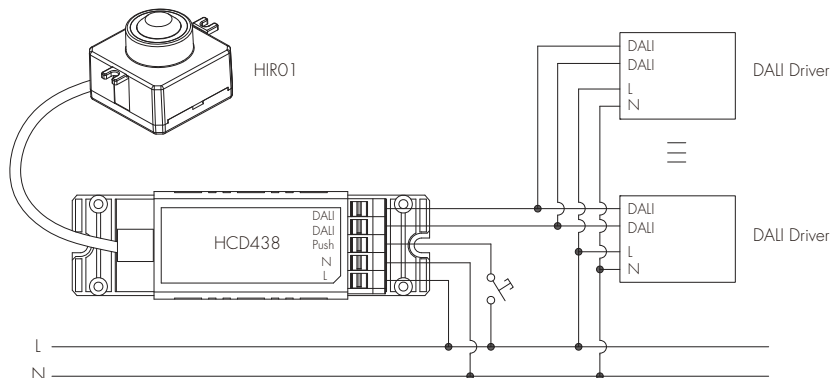

Settings (Remote Control HRC-01)



Permanent ON/OFF function

Press "ON/OFF" button, the light goes to permanent on or permanent off mode.

* Press "Auto Mode", "RESET", "Scene mode" or "8H" button to quit from this mode.



Sensor Mode

Press "Auto Mode" button, the sensor starts to work and all settings remain the same as the last status before the light was switched on/off.



Reset function

Press "RESET" button, all settings go back to default value (same as scene mode 3):

Detection range: 100%; Hold-time: 5min; Stand-by period: 10min;

Stand-by dimming level: 20%; Constant lux: 100lux



Dim +/-

1. Long press "Dim +" or "Dim -" to adjust the brightness of the fixture so that the target area lux level can be constantly maintained. "+" means dimming up, "-" means dimming down.
2. Stop pressing the button when get the target brightness. The built-in daylight sensor reads the total lux available and mark it as the target lux level.
3. If the available natural daylight changes, the daylight sensor can measure and calculate how much artificial light is needed, and adjust the electrical brightness to maintain constant lux value.



Test mode

The button "Test 2s" is for testing purpose only after commissioning. Pressing this button, the sensor goes to test mode (hold-time is only 2s) automatically, and stand-by period and built-in daylight sensor are disabled.

* This mode can be ended by pressing "reset", or any button of "scene mode" and "hold-time".



8H permanent on mode

In some circumstances, people want to disable the sensor and keep the light on for a certain period of time, even there is no motion detected. This function is built-in the software and can be achieved by pressing the "8H" button on the RC.

* Press "ON/OFF", "Auto Mode", "RESET" or "Scene mode" buttons to quit from this mode.

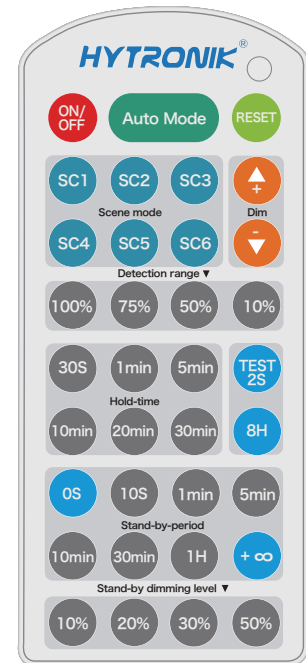

HRC-01

Note: the buzzer beeps one time when RC receives signal successfully.

Scene mode

There are 6 scene modes fixed program built-in the remote control to choose for different applications:

Scene options	Hold-time	Stand-by period	Stand-by dimming level	Constant Lux	Detection range
SC1	1min	1min	10%	50Lux	disabled
SC2	3min	5min	20%	75Lux	disabled
SC3	5min	10min	20%	100Lux	disabled
SC4	10min	30min	30%	150Lux	disabled
SC5	20min	1H	30%	200Lux	disabled
SC6	30min	+∞	50%	400Lux	disabled

End-user can adjust hold-time/stand-by period/stand-by dimming level/ constant lux via the remote control. The latest setting controls.

Hold-time

Press the buttons of "hold-time" to set hold-time at 30s / 1min / 5min / 10min / 20min / 30min .

Stand-by period (tri-level control)

Press the buttons of "stand-by period (tri-level control)" to set stand-by period at 0s/10s/1min/5min/10min/30min/1H/+∞.

Note: "0s" means on/off control; "+∞" means bi-level control, light never switches off.

Stand-by dimming level

Press the buttons of "stand-by dimming level" to set the stand-by dimming level at 10%/20%/30%/50%.

Detection range

Buttons of "detection range" are disabled.

Detection Pattern

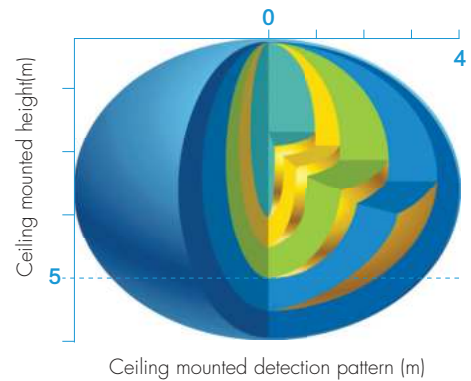

Technical Data

Operating voltage (HIRO1)	5Vdc
Switched power (HC438V)	500W@120V; 1200W@277V
Switched power (HCD438)	DALI Output, max. 15 devices/broadcast 30mA 16Vdc
Stand-by power	<0.5W
Hold-time	Test 2s /30s /1min /5min /10min /20min /30min
Stand-by period	0s /10s /1min /5min /10min /30min /1H /+ ∞
Stand-by dimming level	10% /20% /30% /50%
Sensor principle	PIR detection
Detection range	Max. (Ø x H): 8 x 5m
Detection angle	30°~150°
Mounting height	Max. 5m
Operating temperature	-20°C ~ 55°C
Max. case temperature (Tc)	80°C
IP rating	IP20
Certificate	cULus listed